



Cyclone Instruction Manual

Insulation blowing machine

Intec — 9251 Bruin Boulevard, Frederick, CO 80504 USA

T: 303-833-6644

Web: www.inteccorp.com

Email: info@inteccorp.com

Rev Date: 20211203

Introduction

Thank you for purchasing an Intec insulation system. Since 1977, both professional contractors and do-it-yourself equipment users have looked to Intec as the industry leader in the design and manufacture of innovative portable insulation blowing equipment. We take pride in making your job as easy and profitable as possible.

The right system for your needs: Intec strives to provide you with the best combination of portability, functionality, and installation versatility to surpass your desired success. From lightweight polyethylene units with removable hoppers, to larger units with increased production rates and installation versatility, all of our durable systems are made to maximize your profit generating potential.

Best-in-class Customer Service: Total ease of use extends beyond your initial purchase of an Intec system to your evolving needs thru the entire lifecycle. Both before and after the sale service is important to keep you running at peak operating capabilities. Intec's technical team provides installation assistance in addition to maintenance suggestions and trouble-shooting support. In addition to blowing machines, Intec produces a range of accessories that will increase your productivity when dense packing, damp spraying, and installing net and blow.

Thank you for partnering with Intec. We appreciate the confidence and trust you have placed in us, and wish you many profit-generating opportunities!



A handwritten signature in black ink, appearing to read 'Ray', written in a cursive style.

Ray Lavallee
President, Intec

Table of Contents





INTRODUCTION	1
SYMBOLS.....	3
SAFETY FIRST	3
HOW THE SYSTEM WORKS.....	4
MAINTENANCE	7
TROUBLESHOOTING.....	8
SPECIFICATIONS	10
ELECTRICAL DRAWING	13
MAKING A CLAIM FOR DAMAGE OR LOSS	14
WARRANTY	15

Symbols







SYMBOL	SYMBOL	MEANING
	Danger	Indicates an imminently hazardous situation, which, if not avoided, will result in death or serious injury.
	Warning	Indicates a potentially hazardous situation, which, if not avoided, could result in death or serious injury.
	Caution	Indicates a potentially hazardous situation, which, if not avoided, may result in minor or moderate injury.

Safety First



-  Disconnect all power cords prior to working on the equipment. Failure to do so could result in injury or death.
-  Never operate equipment while standing in water as electrical shock may result.
-  Always use grounded extension cords when operating equipment.
-  Keep hands above safety bars at all times.



-  When working with insulation, always wear a long sleeve shirt, gloves and a hat. Wear goggles or safety glasses for eye protection. Wear a mask for respiratory protection.
-  Never put your hands into the hopper or machine outlet while the machine is operating.
-  Keep tools and foreign objects out of the hopper.
-  Never leave the machine unattended during operation. Disconnect all power to the machine when unattended.
-  Never operate the equipment with the access panels off, possible injury may occur.
-  Prior to use, inspect power cord and remote cord prior to ensure no damage exists.



How the System Works

OVERVIEW: The cellulose insulation is loaded into the hopper. The agitator breaks-up and conditions the insulation for proper density while also sweeping the insulation into the airlock. The airlock transports the insulation into the airstream created by the blower system. Insulation is discharged from the airlock into the hose. The insulation is further conditioned as it travels through the hose.

An introduction to key components of the system follows:

Electrical Panel: The electrical panel, combined with the wired remote, provides operation of the machine.

Hopper: The hopper contains the insulation being fed into the agitators.

Safety bars: Keep hands & foreign objects above the safety bars at all times.

Agitators: The agitators condition the fibrous insulation. The agitators provide high production rates and appropriate insulation conditioning. The agitators also transport insulation into the airlock.

Gate: The slide gate is between the agitators and the airlock. The slide gate allows insulation to fall into the airlock. The slide gate is opened fully during typical operation. Close the gate slightly to increase the conditioning of the insulation.

Airlock: The airlock transfers the insulation from the agitation system into the airstream without coming into contact with the blower. Insulation is discharged from the airlock into the hose.



Looking down into hopper

Set up and Operation



System Set up: Set system on a dry, level surface.

1. Obtain appropriate protective equipment.



2. Attach hose to machine outlet using a hose clamp.



3. Open slide gate.



4. Connect the wired remote to the wired remote receptacle on the control panel.
Caution: Ensure that the toggle switches on the wired remote are in the OFF position. This will ensure that you system does not start when you are not expecting.
5. Connect the supplied twist lock power cord's female end to the machine. Then plug the male end into to a dedicated 115V – 15amp outlet.

System Operation:

1. Activate System

- a. Turn the BLOWER control to the ON position.
- b. Turn the AGITATOR control to the ON position.
- c. Use blower and agitator controls on the remote to operate system.

Notes:

- A. *With all switches – both control panel and remote -- in the ON position, the machine operator can control the machine thru either the control panel buttons or remote switches.*
- B. *The agitator can only come on when the blower is on.*
- C. *Reset circuit breaker if system does not start.*
- D. *Cold Weather: The machine may be hard to start if temperature is below 1 degree Celsius. To assist in cold weather starting, keep machine in warm area for at least 1 hour prior to using.*



2. Load Insulation -- Remove packaging and load insulation.



cellulose

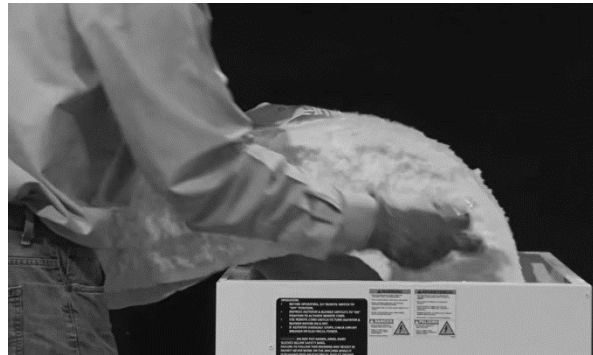

fiberglass

WARNING: Keep hands above safety bars at all times.

3. When complete, blow all insulation out of machine, clean machine, and return machine to the location you obtained it from.

Maintenance

Preventative maintenance will provide for many years of trouble-free use.

Cleaning

Clean the interior and exterior of the machine weekly to help maintain the longevity of the mechanical components in addition to the system's finish. This machine has been designed to work in a dusty environment. However, without periodic cleaning and maintenance, the performance of the machine will decline potentially leading to failure.

Cords

The remote and power cords are subject to considerable wear and tear during normal operation. Inspect all cords prior to use to ensure safe operation. If any damage is observed, be sure to repair it before operating the machine to avoid personal injury. Note: Do not pull on power cord when power cord is plugged into machine or wall as damage may occur.

Airlock and Seals

The airlock assembly is one the most important items to keep in good condition. Foreign objects in the airlock can cause damage and reduce the machine's production. Seal failure is the most common airlock assembly failure. Seal failure prevents the airlock from holding the proper pressure. Seal failure will reduce the machine's production. A machine with seal failure will have air blow out of the airlock into the hopper, reducing the amount of air – and product -- exiting the machine outlet. It is recommended to visually inspected seals each week to ensure proper running condition. Replace airlock seals if a cut or tear is evident. Airlock seals should be replaced every 300 hours of operation, or once per year. Visit www.inteccorp.com or contact Intec for replacement instructions.

Chain

Clean and lubricate the chain once per year. Use a dry lubricant when lubricating the chain; do not use oil as oil will attract foreign particles like dust to chain. If the machine is often used in dusty conditions, then clean and lubricate the chain more frequently than once per year.

Blower

The blower's air intake and fan motor should be cleaned every 20 – 30 hours of use to avoid potential overheating. A vacuum or compressed air should be used for cleaning.

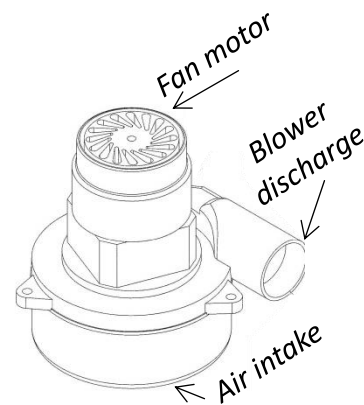

Trouble Shooting

Problem	Likely Cause	Remedy
Machine does not run.	Power cord connection is loose.	Ensure appropriate power cord connection at machine.
		Ensure appropriate power cord connection at power source.
	Power cord not connected at machine or power source.	Connect power cord.
	All switches are not in the "ON" position.	Ensure both control panel & remote switches are in the ON position for system to operate.
	Machine's circuit breaker has tripped.	Push to reset circuit breaker.
	Circuit breaker at power source as tripped.	Reset circuit breaker.
	Electrical system may have a loose wire.	Have the system inspected by a qualified technician.
Machine is on, yet no material comes out of hose.	Slide gate is closed.	Open slide gate.
	Insulation blockage in hose.	Turn system off, remove hose and clear blockage.
	Blower is off.	Turn blower on.
	Air pocket in hopper is preventing insulation from feeding into agitators.	Disconnect electrical power. Redistribute insulation material inside hopper.
	Airlock seal is worn.	Inspect airlock seals for cuts and wear. Have a qualified technician replace airlock seals.

Problem	Likely Cause	Remedy
Insulation exiting hose is dribbling out.	Heavy insulation material.	Push slide gate in 1-2 holes.
	Kink in hose.	Straighten hose.
	Airlock seal is worn.	Inspect airlock seals for cuts and wear. Have a qualified technician replace airlock seals.
Blower does not operate.	Worn brushes in blower motor.	Have a qualified technician replace blower brushes or replace blower motor.
Agitator does not operate.	Insulation is jamming the agitator.	Disconnect electrical power. Remove insulation material from hopper. Remove the obstruction.
	Insulation blockage in airlock exit tube.	Disconnect electrical power. Remove hose from the machine outlet. Locate blockage and remove.
	Agitator or airlock bearing may need replacement.	Have bearing replaced by a qualified technician.
Circuit breakers need resetting often.	Low voltage or low amperage.	System requires 115V / 20amp or 230V / 10amp.
	Extension cord gauge is too small.	Use a 12/3 extension cord with 115V, or a 16A/250V 1.0mm ² extension cord with 230V.
	Chain is not aligned with sprockets.	Disconnect electrical power. Have a qualified technician realign chain and sprockets.
Machine makes a banging noise when agitator is operating.	Chain is loose.	Disconnect electrical power. Have a qualified technician adjust chain tensioner.
		Adjust chain tensioner.
	Chain is not aligned with sprockets.	Disconnect electrical power. Have a qualified technician realign chain and sprockets.

Specifications

Weight	69kg 152 lbs
Blower	2.8 m ³ /min, 230VAC 4.9 amp 104 CFM, 115VAC, 8 amp
Drive Motor	0.37kW, 230VAC, 4.1 amp ½ HP, 115VAC, 7.8 amp
Power Requirements	230VAC, 50Hz, 8 amp circuit 115VAC, 60 Hz, 15 amp circuit



Electrical Drawing

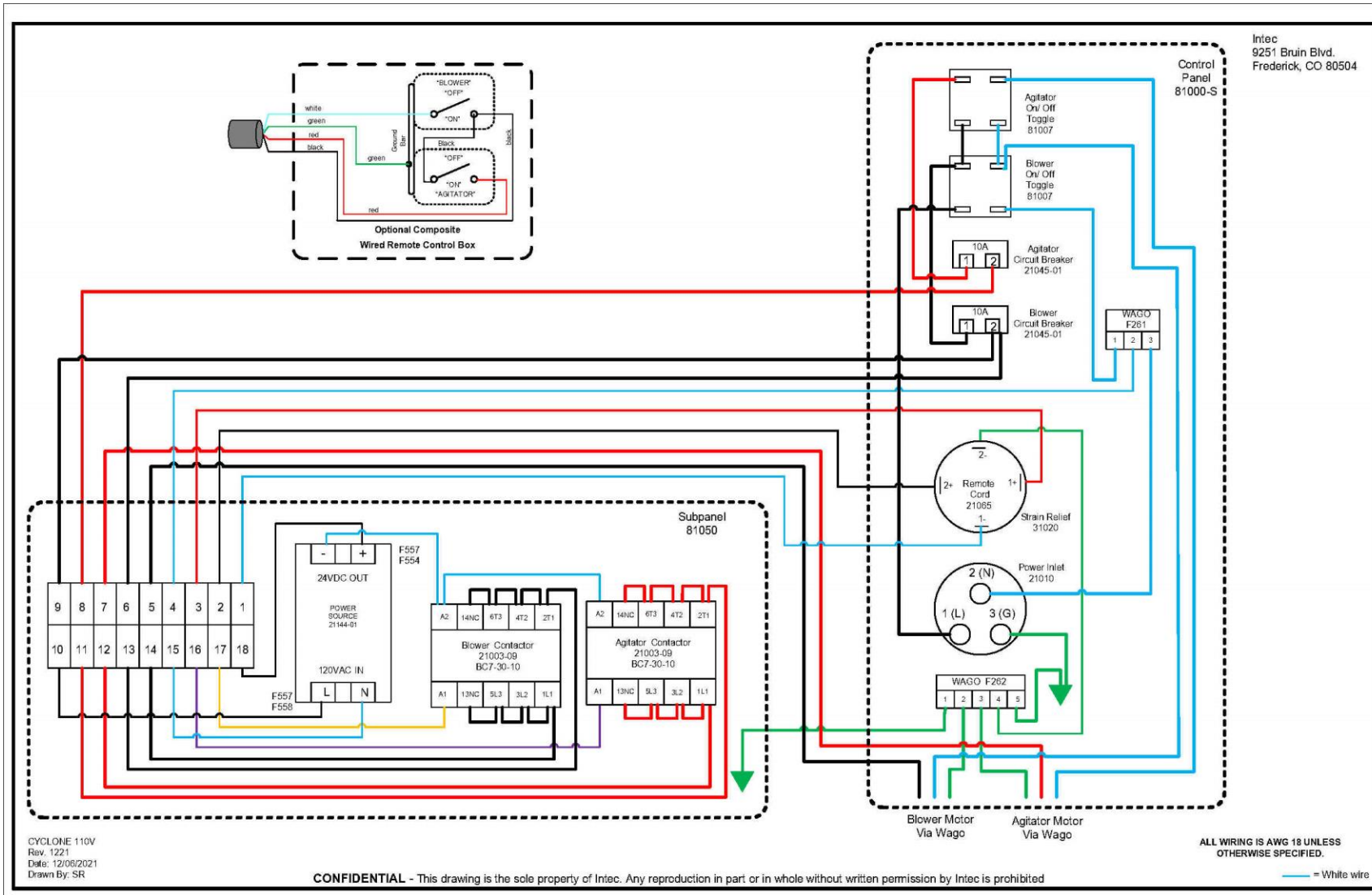

Making a Claim for Damage or Loss

Your Intec products were carefully packed and thoroughly inspected before leaving our factory. We understand that damage to or defects with your system may unfortunately occur. Please inspect your shipment carefully upon arrival and save the shipping containers and packaging materials in case of damage.

The following table provides you with appropriate actions to take when certain issues are realized.

ISSUE	Action to Take
<p>1 <i>DAMAGE in Transit</i></p> <p>A Visible PRIOR to unpacking (Damage to carton or packing material).</p> <p>B Visible AFTER unpacking (Only apparent when unpacked).</p> <p>C Shortage (# containers does not agree to transportation bill).</p> <p>When items leave our warehouse, the shipper assumes responsibility. It is the responsibility of the consignee to file a claim. Proper documentation is necessary to support the claim. Please inspect all items properly prior to signing for them.</p>	<p>File Claim with appropriate freight carrier.</p> <p>File Claim with appropriate freight carrier.</p> <p>File Claim with appropriate freight carrier.</p>
<p>2 <i>Items received not correct</i></p> <p>A Incorrect items received.</p> <p>B Incomplete order received (not backordered).</p>	<p>Contact Intec Customer Service</p> <p>Contact Intec Customer Service 303.833.6644 info@inteccorp.com</p>
<p>3 <i>Issue within the warranty period</i></p> <p>A Troubleshooting (machine or part not operating as intended).</p> <p>B Replacement part(s).</p> <p>Intec can assist with troubleshooting your issue, and can get you back up and running. If warranty parts are required, a return material authorization (RMA) will be issued by technical service.</p>	<p>Contact Intec Customer Service</p> <p>Contact Intec Customer Service 303.833.6644 or info@inteccorp.com</p>
<p>4 <i>Issue outside of warranty period</i></p> <p>A Replacement part, troubleshooting.</p> <p>B Need assistance from a service center.</p>	<p>Contact Intec Customer Service</p> <p>Contact Intec Customer Service 303.833.6644</p>

Shipping Department
Intec
9251 Bruin Boulevard
Frederick, CO 80530-0579

phone: 303-833-6644
fax: 303-833-6650
email: info@inteccorp.com
website: www.inteccorp.com

Warranty

It is expressly understood and agreed that no officer, agent, salesman or employee of the manufacturer Intec (MANUFACTURER) has the authority to obligate the MANUFACTURER by any terms, stipulations, or conditions not herein expressed; that all previous representations and agreements, either verbal or written, referring to the machinery and equipment, which is the subject of this Warranty, are hereby superseded and canceled, and that there are no promises or agreements outside of the Warranty agreement. Furthermore, the MANUFACTURER hereby disclaims any implied warranties of merchantability, or implied warranties of fitness for a particular purpose.

With the above understanding, the MANUFACTURER provides the following one (1) Year Limited Warranty, and no other, for its insulation blowing machines (MACHINES):

- a) MANUFACTURER warrants to the original purchaser that the MACHINE is well made, of good material and durable; but only if the MACHINE is operated and maintained in accordance with the Instruction Manual. This Warranty is void if the MACHINE is not so operated and maintained, or if the MACHINE is used for blowing materials other than those which are intended to be used with the MACHINE.
- b) MANUFACTURER guarantees the MACHINE to be free from manufacturing defects at the time of shipment, and to remain free from defects when operated under normal use, for a period of one (1) year from the date of factory shipment, with the exception of the blowers, electrical and air lock components, which are warranted for a period of ninety (90) days from date of factory shipment.
- c) This Warranty shall not apply to any MACHINE or component part which, in the opinion of the MANUFACTURER, has been altered, subject to misuse, negligence, accident or operated beyond factory rated capacity. All requested Warranty work should be performed at MANUFACTURER's factory or by an Authorized Factory Service Facility. Failure to have the Warranty work done at MANUFACTURER'S factory or by an Authorized Factory Service Facility will void this Warranty. MANUFACTURER will bear full responsibility to repair or replace, at its option, without charge to the original purchaser, any part that, in the MANUFACTURER'S opinion, is found to be defective.
- d) All parts claimed defective by original purchaser shall be returned, properly identified, to MANUFACTURER's factory or Authorized Factory Service facility, freight prepaid. All replacement, repaired or non-defective parts will be returned to purchaser, freight collect. MANUFACTURER will supply replacement parts prior to purchaser, freight collect. MANUFACTURER will supply replacement parts prior to receipt of any parts claimed defective, only with the understanding that such replacement parts will be shipped to purchaser at the then prevailing price of said part, C.O.D., freight collect. MANUFACTURER will reimburse cost of any such part only after receipt and inspection, and finding said part defective.
- e) MANUFACTURER's liability is expressly limited to the repair or replacement of defective parts set forth in this Warranty. All other damages and warranties, statutory or otherwise, being waived are original purchaser as a condition of sale and purchase of said machines. Furthermore, the MANUFACTURER shall not be liable for damages or delays caused by defective material or workmanship.